

ready to assemble -- tools required:
electric drill with phillips bit and/or a phillips screwdriver, small pair of pliers

item #15058
overall dimensions
78.75" L X 37.4" W X 47.25" H
200 cm x 95 cm x 120 cm

**rustic ranch
assembly instructions**
warepet.com

Thank you for your purchase. Follow these detailed instructions to properly assemble your new **rustic ranch coop**. To ensure assembly success, please read all care guides carefully prior to assembly and installation.

warnings & cautions



- Coop should be placed on a flat level surface for stability.
- Keep small parts away from pets/children to avoid choking hazard.
- Follow instructions in this manual to avoid personal injury to pet or property damage.
- This coop is for chicken use only, it is not suitable for children or other animals.
- Keep all tools and instructions in a safe place for future reference.
- Always supervise your flock when using this item. Inspect product regularly and re-tighten screws as needed.
- For additional stability, coop can be anchored to the ground.





warepet.com

If you have any questions or concerns about this product contact our customer service department at 1-800-295-2243 Mon-Fri 8:00 - 4:00 MST or email us at hello@warepet.com



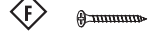

Due to ongoing product improvements, product photo on packaging may not match finished product.

HARDWARE

	(M6 x 50mm)	8pcs	#902811
	(M6 x 40mm)	22pcs	#902812
	1-3/8" (3.5 x 35mm)	6pcs	#902813

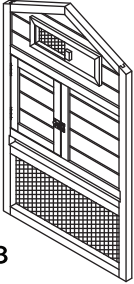
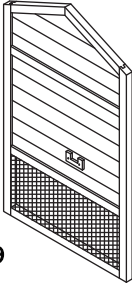
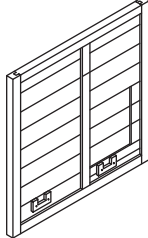
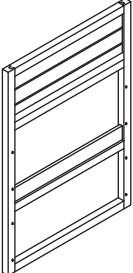
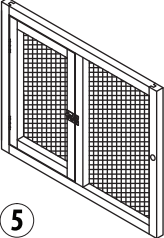
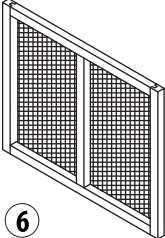
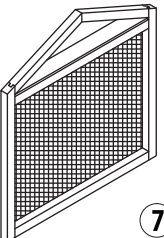
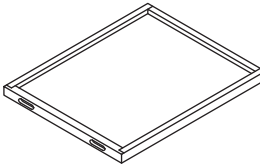
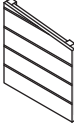
	1-3/16" (3.5 x 30mm)	16pcs	#902814
	1" (3.5 x 25mm)	8pcs	#902815
	1/2" (3.0 x 16mm)	4pcs	#902816
	1 pc	#902817	

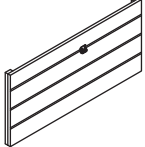
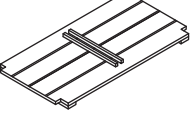
PARTS

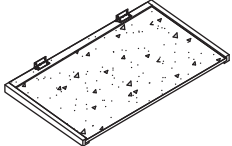
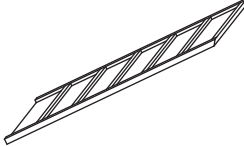
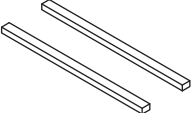
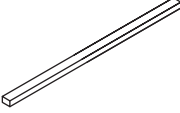
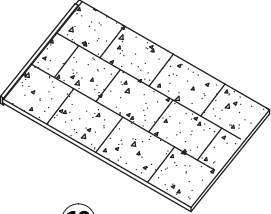
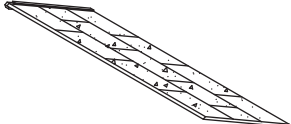
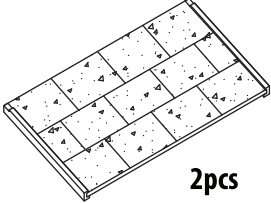
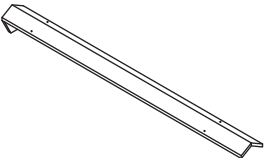
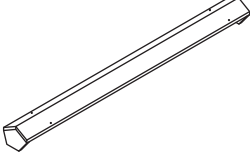
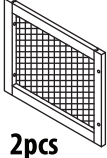
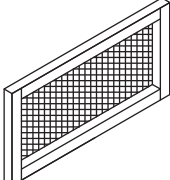
 ① #902818	 ② #902819	 ③ #902820	 ④ #902821
 ⑤ #902822	 ⑥ #902823	 ⑦ #902824	 ⑧ #902825
 ⑨ #902826	 ⑩ #902827	 ⑪ #902828	 ⑫ #902829
 ⑬ #902830	 ⑭ #902831	 ⑮ #902832	 ⑯ #902833
 ⑰ #902834	 ⑱ #902835	 ⑲ #902836	 2pcs ⑳ #902837
 ㉑ #902838	 ㉒ #902839	 2pcs ㉓ #902840	 ㉔ #902841

warepet.com

If you have any questions or concerns about this product contact our customer service department at 1-800-295-2243 Mon-Fri 8:00 - 4:00 MST or email us at hello@warepet.com

Due to ongoing product improvements, product photo on packaging may not match finished product.

STEP 1

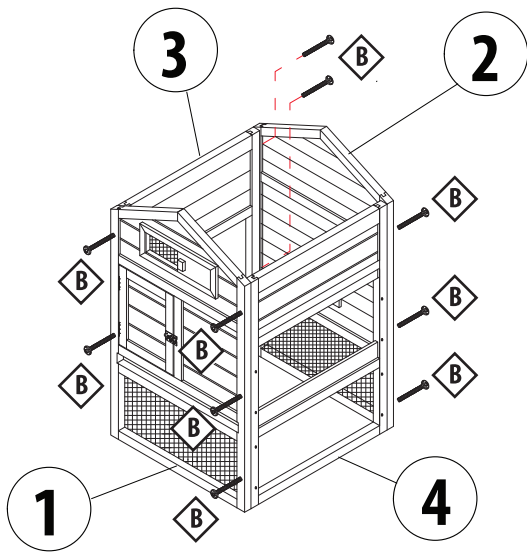

B  (M6 x 40mm) 10pcs

STEP 2

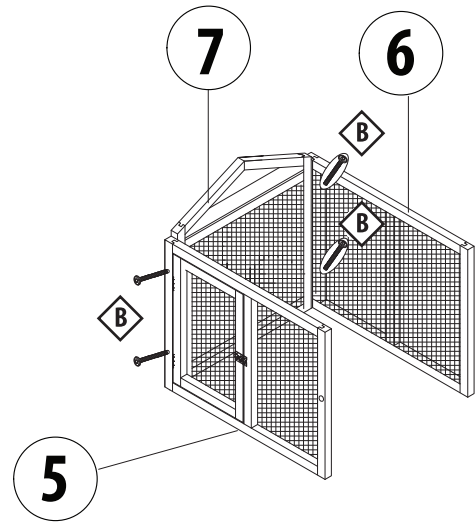

B  (M6 x 40mm) 4pcs

STEP 3

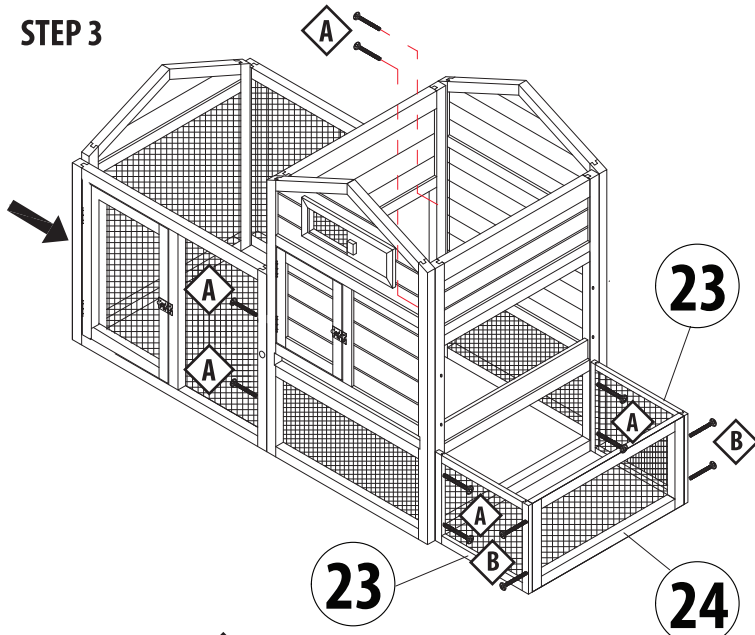



A  (M6 x 50mm) 8pcs

B  (M6 x 40mm) 4pcs

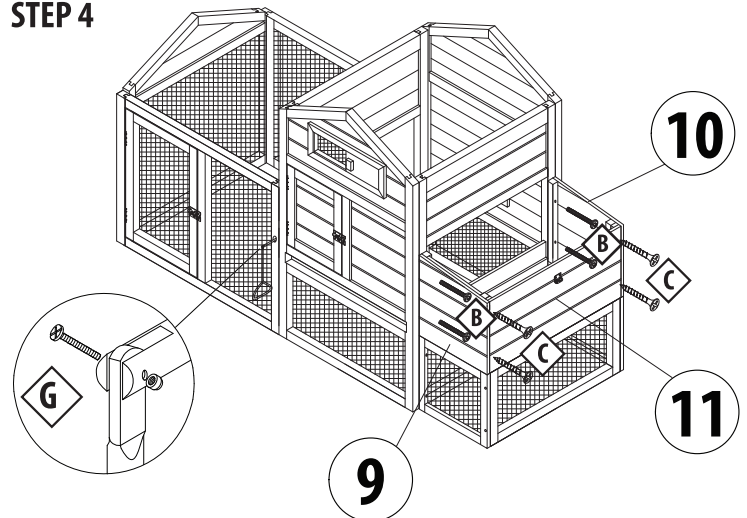
STEP 4



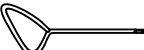

B  (M6 x 40mm) 4pcs

C  1-3/8" (3.5 x 35mm) 4pcs

G  1 pc

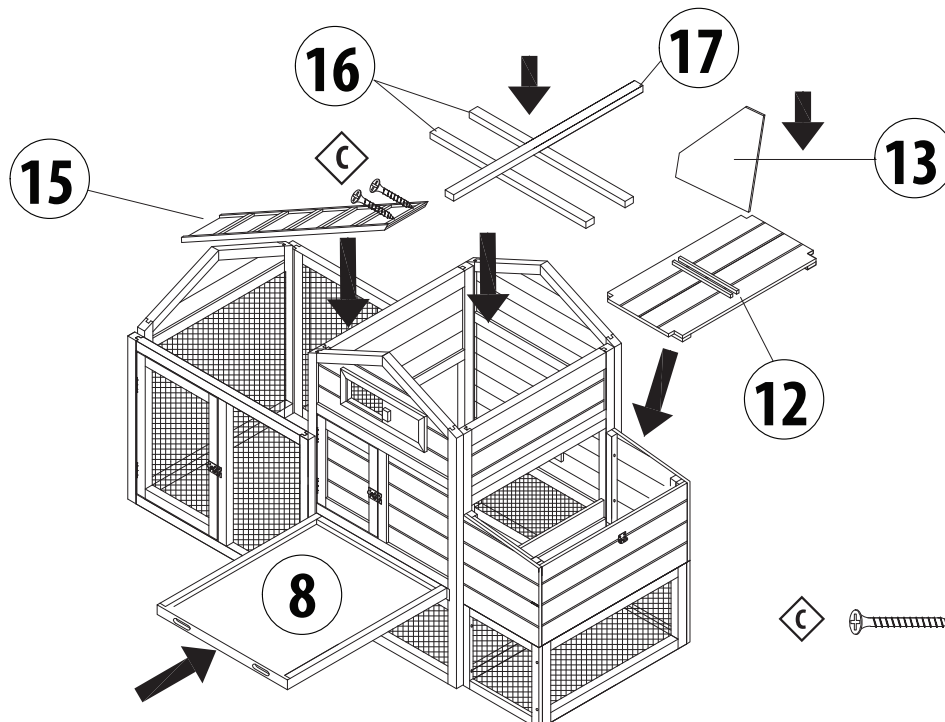



STEP 5



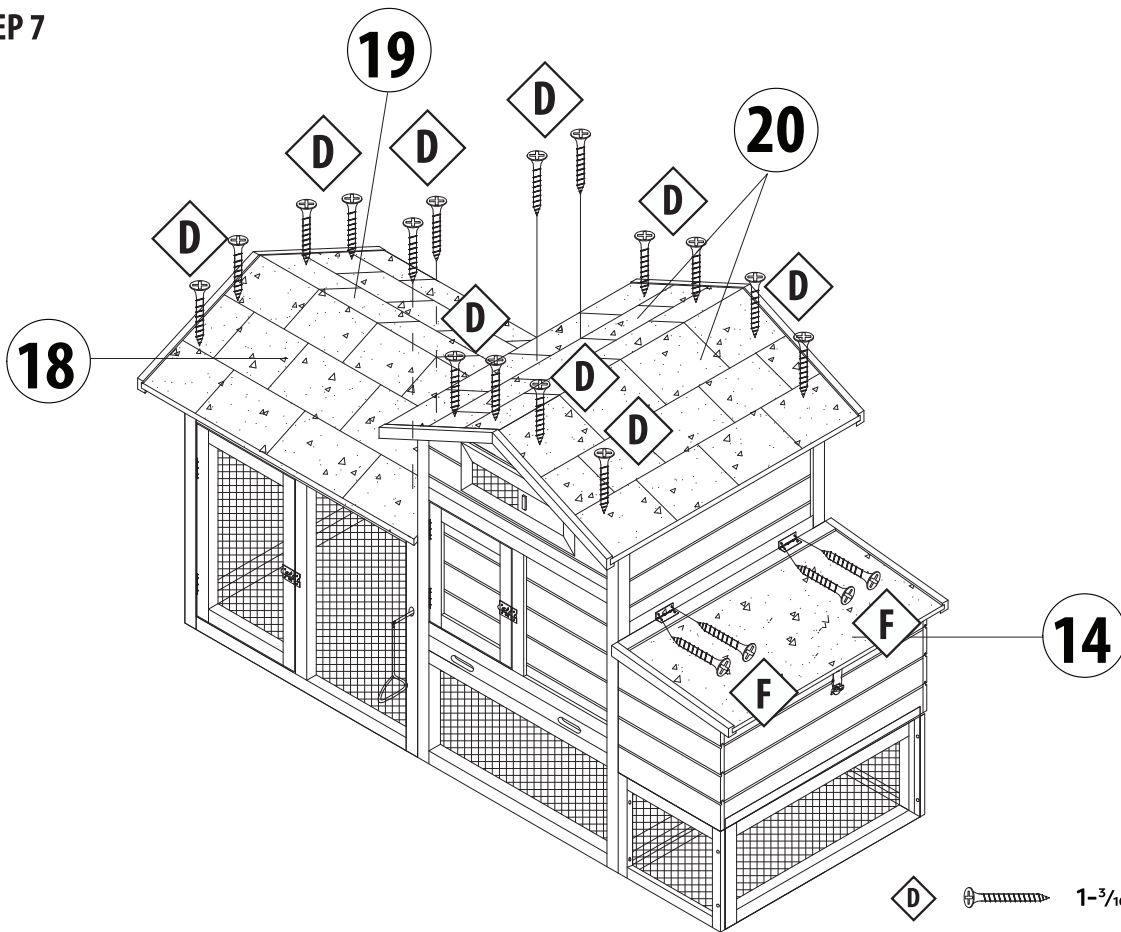

C  1-3/8" (3.5 x 35mm) 2pcs

STEP 7

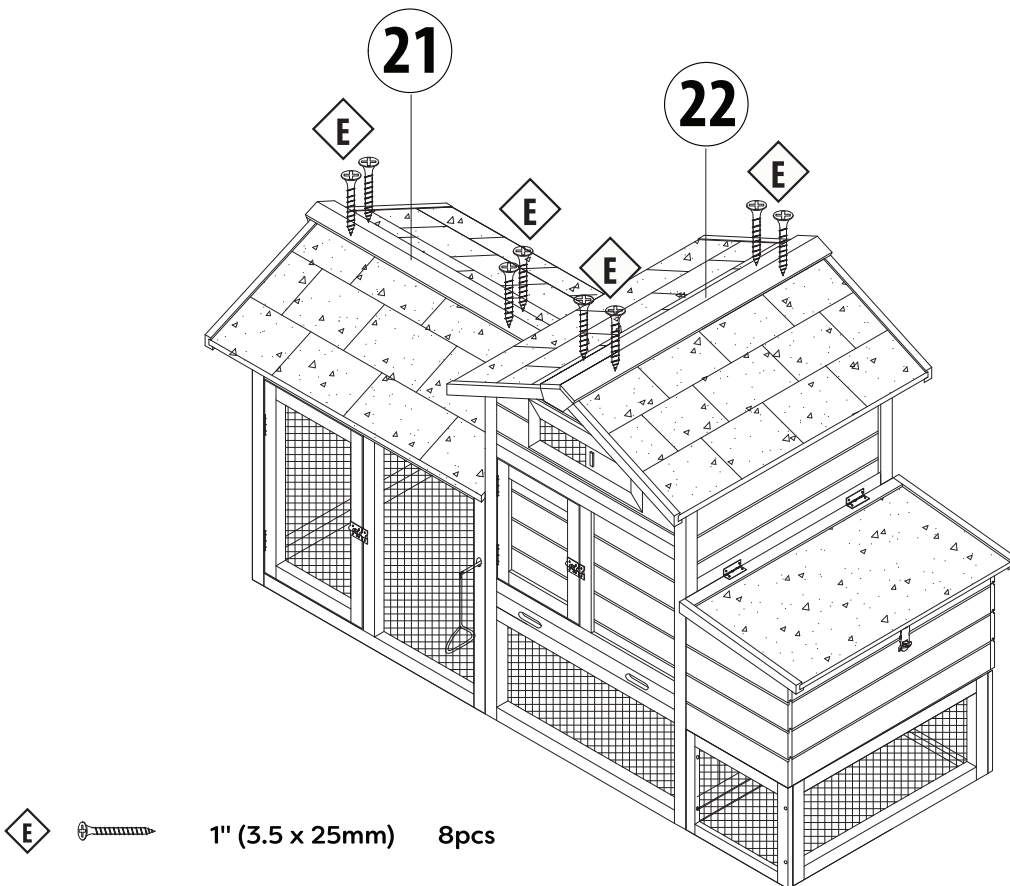

-   1-³/₁₆" (3.5 x 30mm) 16pcs
-   1/2" (3.0 x 16mm) 4pcs



-   1" (3.5 x 25mm) 8pcs

Assembly is now complete

care tip

To protect the wood on your pen you need to re-apply the protective stain finish at least 1x each year. Use a safe and non-toxic water based stain (available at your local paint or hardware center). Keep pen in a safe area away from high winds and extreme temperatures.